

AGW-500-4 Parallel Gripper

Wide-Body, Synchronous/Non-Synchronous

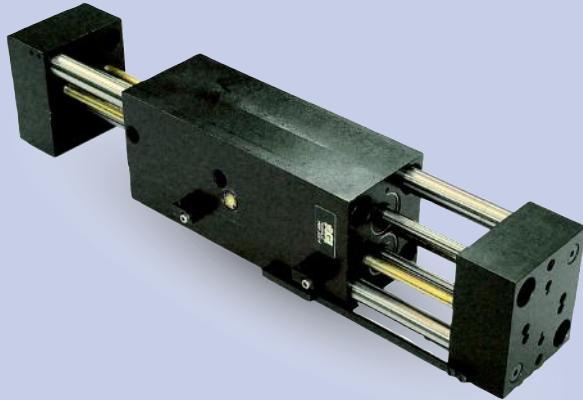

FEATURES AND BENEFITS

- Ultra high gripping force to weight ratio due to four opposing independent pistons that direct power to the jaws.
- True parallel jaw motion for easy tooling.
- Units are permanently lubricated for non-lube air operation, allowing for compliance with OSHA regulations.
- Large jaw support shafts are guided through the full width of the main body.
- Proximity switches are available to monitor open and closed position of the jaws.
- The AGW Series is fully field repairable for cost savings and minimum down time.
- Non-synchronous versions allow the gripper's jaws to comply to the part's centerline versus the gripper's centerline.

SPECIFICATIONS

Design: Parallel, Double Acting, Synchronized Jaws

Stroke: 4 in [101.6 mm]

Gripping Force @ 80 PSI Per Jaw [5.5 BAR]

Closing: 84 lbs [373 N]

Opening: 86 lbs [383 N]

Time:

Close: 0.5 sec [0.5 sec]

Open: 0.5 sec [0.5 sec]

Pressure Range:

Low/High 20-120 PSI [1.7-8 BAR]

Temperature Range:

Low/High -20°/180°F [-28°/80°C]

Side Play:

± 0.001 [.03 mm]

Repeatability from Center:

± 0.002 [.06 mm]

Loading Capacity:

| | Static | Dynamic |
|-------------------|---------------------|-------------------|
| Max Tensile T | 500 lbs [2220 N] | 50 lbs [222 N] |
| Max Compressive C | 500 lbs [2220 N] | 50 lbs [222 N] |
| Max Moment M_x | 500 in/lb [56.5 Nm] | 50 in/lb [5.6 Nm] |
| Max Moment M_y | 750 in/lb [85 Nm] | 75 in/lb [8.5 Nm] |
| Max Moment M_z | 500 in/lb [56.5 Nm] | 50 in/lb [5.6 Nm] |

Material: High Strength, Hard Coated aluminum bronze alloys, Steel

Weight: 6 lbs [2.7 kg]

Piston Diameter: .875 in x 4 [22.3 mm]

January 2009 - PATENTED Made in the USA

HOLDING FORCES CHART

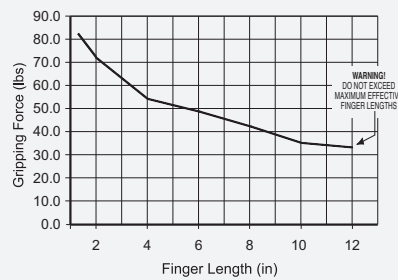

WARNING! Do not exceed tooling jaw length. See Chart above.

LOADING INFORMATION

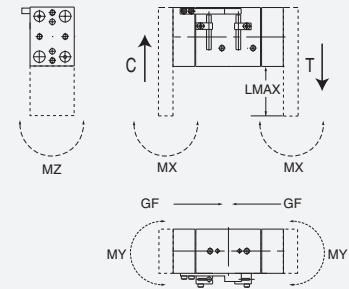

LOOK! More Technical specifications for sensors on "Sensors Accessories" page.

HOW TO ORDER

When ordering, please specify:
Design/Model Number and Options.

DESIGN/MODEL

- AGW-250
- AGW-375-1
- AGW-375-2
- AGW-375-4
- AGW-500-1
- AGW-500-2
- AGW-500-4
- AGW-625-2
- AGW-625-4
- AGW-625-6

SENSOR OPTIONS

- 1 = CLOSED
- 2 = OPEN
- 3 = BOTH

SENSOR TYPE*

- 1 = NPN
- 2 = PNP

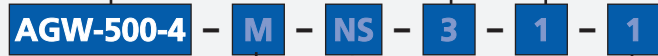

TYPE
M = METRIC
= IMPERIAL

NON-SYNCHRONIZED OPTION

SENSOR CONNECTOR

- 1 = POTTED
- 2 = QUICK DISCONNECT
- 3 = QUICK DISCONNECT WITH RIGHT ANGLE

* NOTE: Proximity 4mm dia., 5-24 VDC, 22 mA and comes with 2 meter cable.

Sensor Part # SNQ04, SNC04, SPC04, SPQ04

AGW-500-4 Parallel Gripper

Wide-Body, Synchronous/Non-Synchronous

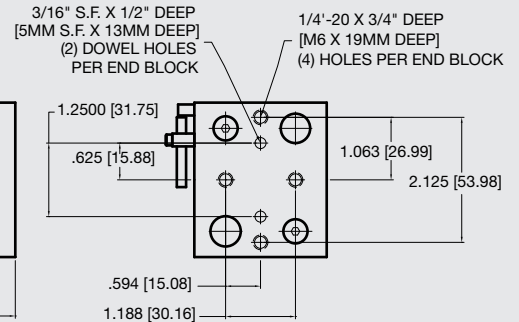
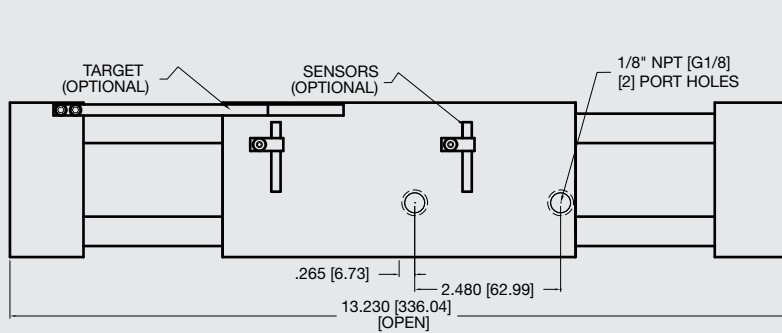
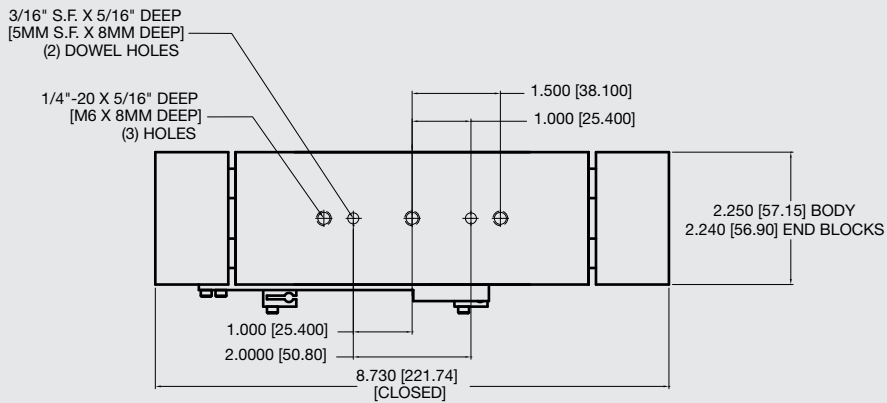
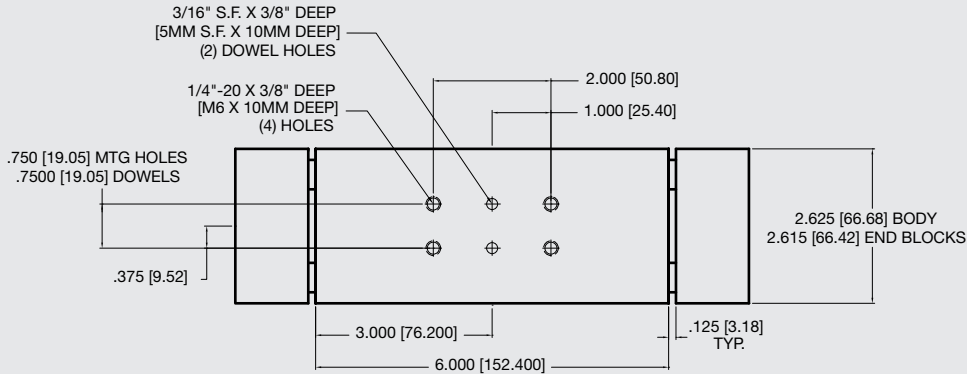

Unless noted, all tolerances are as indicated here:



All Dowel Holes are SF (Slip Fit) Locational Tolerance $\pm .0005"$ [0.13mm]



Metric Threads Course Pitch

Imperial: 0.00 = ± 0.1
Inch 0.000 = ± 0.005
0.0000 = ± 0.0005

Metric: [0.] = ± 0.25
[mm] [0.0] = ± 0.13
[0.00] = ± 0.13